

MIGNON - IVR 927 - IVR 928



Mini valvola mignon - attacchi F/F
 Mini-valve mignon - threaded ends F/F
 Kugelhahn Mignon - IG/IG
 Mini vanne mignon - fixations F/F
 Мини шаровой "миньон" - соединения В/В



IVR 927



Mini valvola mignon - attacchi M/F
 Mini-valve mignon - threaded ends M/F
 Kugelhahn Mignon - IG/IG
 Mini vanne mignon - fixations M/F
 Мини шаровой кран "миньон" - соединения Н/В



IVR 928



IMPIEGHI: Le valvole a sfera MIGNON sono adatte per acqua ed aria compressa.

APPLICATIONS: The ball valves MIGNON series are suitable for water and compressed air.

N. N.	DENOMINAZIONE PART NAME	MATERIALE MATERIAL	TRATTAMENTO TREATMENT
1	Corpo - Body	Ottone - Brass CW 617N - UNI EN 12165/98	Nichelato - Nickel plated
2	Ghiera - Ring	Ottone - Brass CW 614N - UNI EN 12165/98	
3	Seggio - Seat	PTFE	
4	Sfera - Ball	Ottone - Brass CW 614N - UNI EN 12165/98	Cromata - Chrome plated
5	Asta - Stem	Ottone - Brass CW 614N - UNI EN 12164/98	
6	O-Ring - O-Ring	NBR	
7	Maniglia - Handle	Alluminio - Aluminium GD-Al Si 12 CU - UNI 5076/74	Verniciata - Painted
8	Vite - Screw	Acciaio - Steel	Zincato - Zinc plated

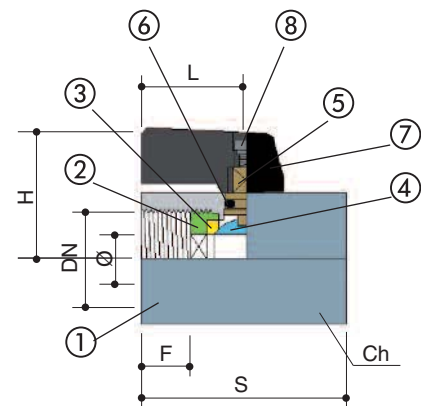

IVR 927

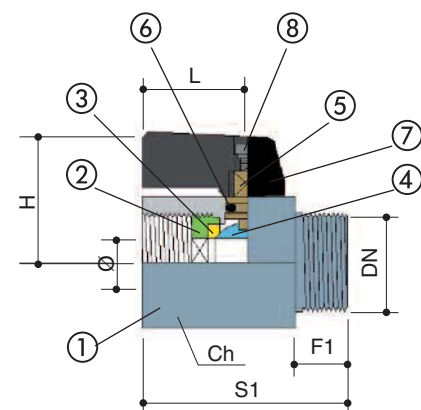

IVR 928

DN	1/8"	1/4"	3/8"	1/2"
Ø	6	8	8	10
F	9	9	10	12
F1	10	10	10	11
S	39	40	41	46
S1	40	40	40	46
H	27	27	27	29
L	23	23	23	23
Ch	20	20	20	24

Dimensioni in mm - Dimensions in mm

DATI TECNICI - TECHNICAL DATA	
Pressione di esercizio Working pressure	10 bar
Temperatura di esercizio Working temperature	0°C + 90°C
Filettatura estremità Threaded ends	UNI ISO 228/1
Asta antisceppio Anti blow-out stem	